



Doors for Living

Residential Doors

Cavity Sliders

Pre-finished Doors

Urbinos Aluminium

Fire Doors

Acoustic Doors

Hospital Doors





Setting the standard
in door manufacturing



RESIDENTIAL DOORS



FIRE DOORS



ACOUSTIC DOORS



CAVITY SLIDERS



HOSPITAL DOORS



URBINOS ALUMINIUM



PRE-FINISHED DOORS

The Hallmark Group are known within the industry for producing quality solutions for commercial and residential interiors. Hallmarks architecturally styled products include residential and commercial doors, fire and acoustic doors, hygiene and pre-finished doors, veneer doors and cavity sliders.

From modest beginnings in 1991 as Interior Timbers to their comprehensive development into the Hallmark Group, this family owned business is now one of the most high profile door manufacturers in New Zealand with distribution networks in both the North and South Islands.

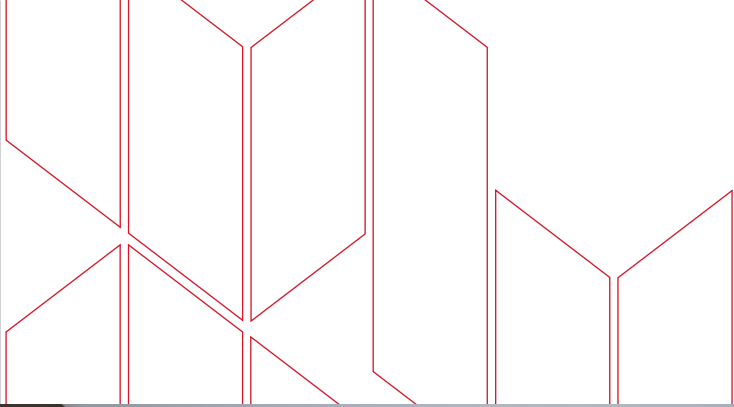

Covering all aspects of interior construction, Hallmark Group has become the preferred choice nationwide for any commercial or residential project. Attention to quality, dedication to service, and commitment to proactive project management, are all contributing factors to Hallmark Groups prized market position. Our Project Team works with Designers and Specifiers early in the development and construction process selecting veneers, specifying performance rated doors, and working through technical specifications to ensure successful outcomes.

Hallmark Group has a proud history of success and a forward thinking architectural approach to being the best in their industry.



The Hallmark door division produces the most comprehensive range of doors on offer in the market, manufactured right here in New Zealand.

CONTENTS

4 Hallmark Classic Collection
Interior & Exterior Doors



6 Hallmark Classic Collection
Vision Panel Options



8 Hallmark Vogue Collection
Interior & Exterior Doors



10 Hallmark Vogue Collection
Vision Panel Options



12 Hallmark Timber Veneer Doors
New Zealand Veneers



13 Hallmark Timber Veneer Doors
Exotic Veneers



14 Hallmark Architectural Collection



15 Hallmark Milano Collection



16 Hallmark Cavity Sliders



20 Hallmark Pre-Finished Collection



22 Hallmark Urbinos
Aluminium Jamb System



24 Hallmark Fire Doors



26 Hallmark Door Warranty



Hallmark Classic Collection

INTERIOR & SHELTERED EXTERIOR DOORS

GROOVED DOORS



INTERIOR OR
SHELTERED
EXTERIOR

A range of high quality interior and sheltered exterior grooved doors, this collection utilises Hallmark's unique framing system and a 4.75mm thick premium skin (MDF for interior doors, tempered hardboard for sheltered exterior doors). The Hallmark Classic Collection is available ex-stock as an interior door range option up to 2400mm high (Hollowcore & Solidcore only).

For the sheltered exterior door range, the tempered hardboard skin provides weather protection & stability. The Classic exterior doors are suitable for sheltered entranceways (minimum 1200mm eave covering), and are the perfect way to establish tone and enhance the street appeal of your home. All interior doors up to 1210mm wide include a UV primer coating to prevent moisture ingress & increase stability.

Special designs are available upon request.



5 x 2.5mm
V-GROOVE
(Standard)



5 x 2mm
SQUARE
GROOVE



10 x 1.5mm
GROOVE
(Chamfer groove)



3 x 1.5mm
U-GROOVE

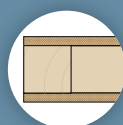

4.75mm
MDF SKIN
(Interior use)

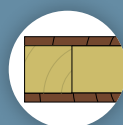

4.75mm
TEMPERED
HARDBOARD SKIN
(Sheltered exterior use)

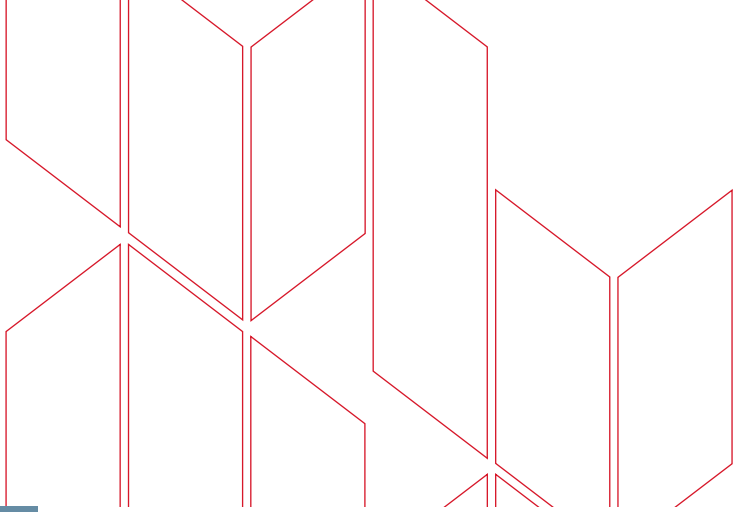

All doors are available in Hollowcore, Solidcore and Polystyrene Core.

All doors are available in any height between 1980mm & 2400mm.

Extra-overheight options are available (2400mm-2700mm MDF only).

Standard lead-time applies for any oversize options and the manufacture of Hallmark Classic Collection sheltered exterior doors.

All designs are v-groove as standard. Chamfer groove, u-groove & square groove options are available on request.

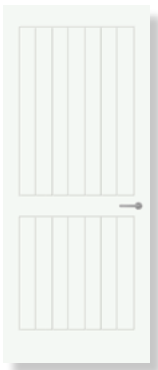

Wanaka

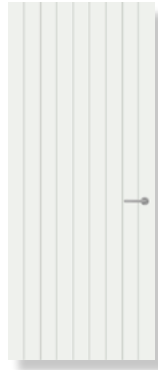

Merivale



Northwood

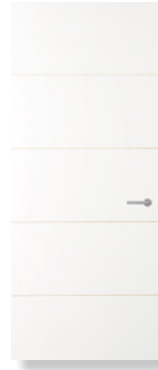

Coromandel



Parnell



Fendalton

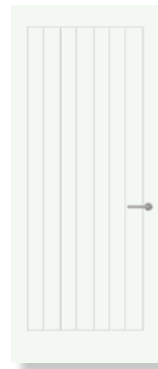

Cashmere



Milford



Richmond



Orewa



Tasman



Aoraki



Brighton

Hallmark Classic Collection

INTERIOR & SHELTERED EXTERIOR DOORS

VISION PANEL OPTIONS



INTERIOR OR
SHELTERED
EXTERIOR

An extension to the v-groove doors, this Hallmark Classic Collection of vision panel doors come with premium 4.75mm skins for greater stability, impact resistance and a high quality paint finish.

Special designs are available upon request.



FLUSH
BEADING



REBATED
BEADING

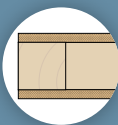

4.75mm
MDF SKIN
(Interior use)

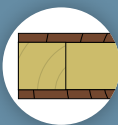

4.75mm
TEMPERED
HARDBOARD SKIN
(Sheltered exterior use)

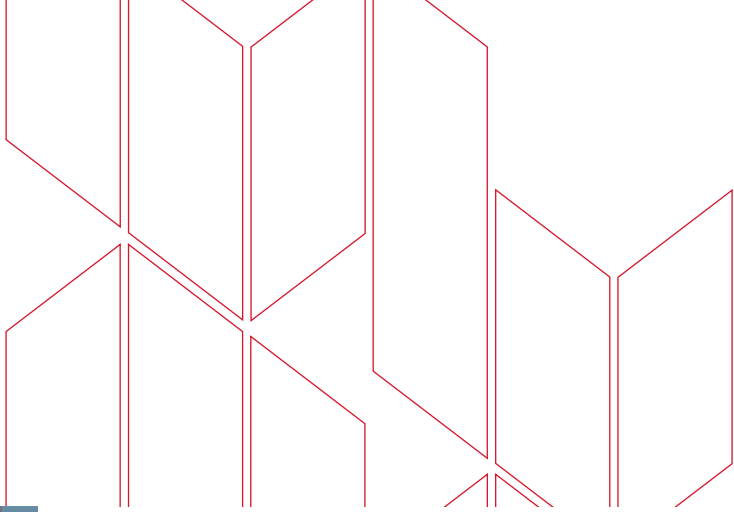

Hollow, solid & polystyrene core options available. Doors available up to 2700 x 1210mm. Doors finish at 38mm thick as standard. Steel insert options available.



Glazing Option 1



Glazing Option 2



Glazing Option 3



Glazing Option 4



Glazing Option 5



Glazing Option 6



Glazing Option 7

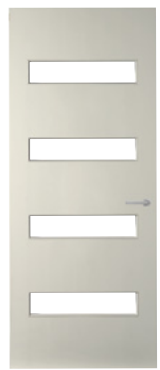

Glazing Option 8



Glazing Option 9 (Parnell)



Glazing Option 10 (Parnell)



Glazing Option 11 (Fendalton)



Glazing Option 12 (Fendalton)



Glazing Option 13 (Classic)

PLEASE NOTE: GLASS IS NOT INCLUDED. ALL PANELS ARE BEADED, PLEASE SELECT EITHER FLUSH OR REBATED BEADING. Please contact your local merchant or glazier for glazing prices.

Hallmark Vogue Collection

INTERIOR & SHELTERED EXTERIOR DOORS

ROUTERED PANEL DOORS



Featuring a stylish rout design with several popular patterns to select from, the Vogue routed panel collection completes the look in today's modern home. All designs feature Hallmarks 25mm wide square corner rout and are available with MDF for interior and tempered hardboard for sheltered exterior doors.

All doors come with premium 4.75mm skins for greater stability, impact resistance and a high quality paint finish. All interior doors up to 1210mm wide include a UV primer coating to prevent moisture ingress & increase stability.

ROUTERED GROOVE DETAIL

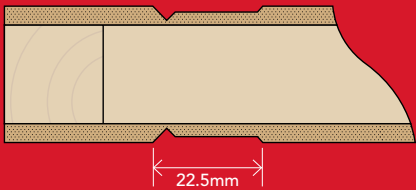

4.75mm
MDF SKIN
(Interior use)

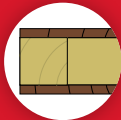

4.75mm
TEMPERED
HARDBOARD SKIN
(Sheltered exterior use)

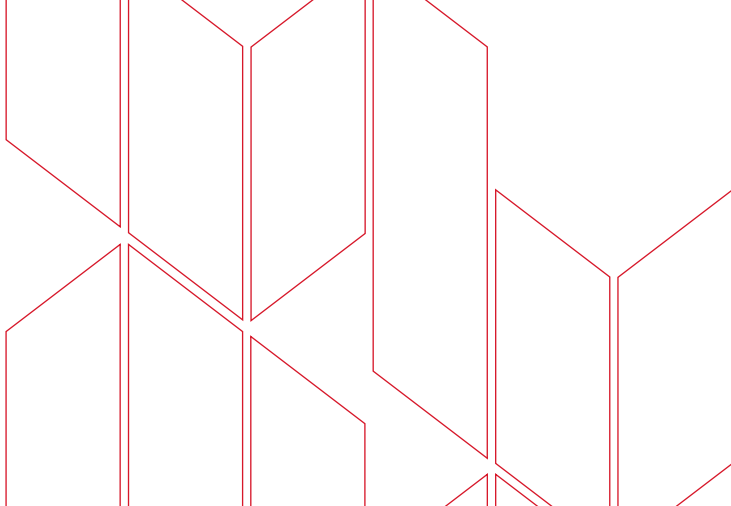

- Doors available in hollow core, polystyrene core and solid core
- Doors available up to 2700 x 1210mm
- Doors finish 38mm thick as standard. Other thickness options available
- Steel inserts for greater stability are available (recommended on all cavity slider doors)



VRP1



VRP2



VRP3



VRP4



VRP5



VRP6



VRP7



VRP8

Hallmark Vogue Collection

INTERIOR & SHELTERED EXTERIOR DOORS

VISION PANEL OPTIONS





INTERIOR OR
SHELTERED
EXTERIOR

If it's a stylish entrance you're after, the NZ made Vogue vision panel collection has your options covered. This large and high quality selection features many different architectural designs to give your home its own signature.

Should you wish to continue your look beyond the entrance, the Vogue Vision Panel Collection is manufactured with both MDF and tempered hardboard for interior and sheltered exterior applications. All doors come with premium 4.75mm skins for greater stability, impact resistance and a high quality, interior UV paint finish.

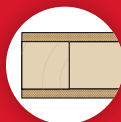
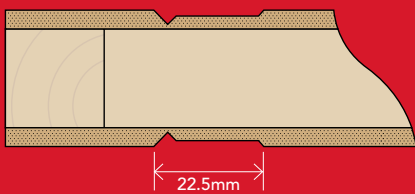
ROUTERED GROOVE DETAIL



4.75mm
MDF SKIN
(Interior use)

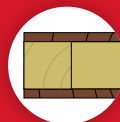

4.75mm
TEMPERED
HARDBOARD SKIN
(Sheltered exterior
use)



FLUSH
BEADING



REBATED
BEADING

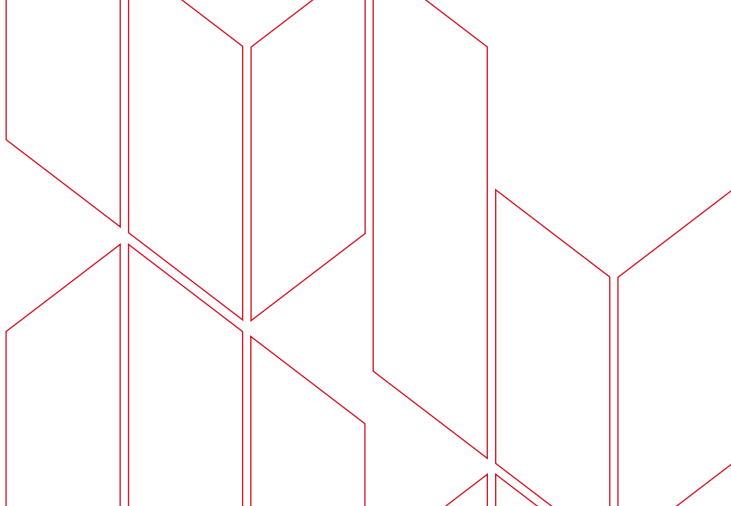

Hollow, solid & polystyrene core options available. Doors available up to 2700 x 1210mm. Doors finish at 38mm thick as standard. Steel insert options available.



VVPA



VVPB



WVPC



VVPD



WVPE



VVPF



VVPG



VVPH



WVPI



VVPJ



WVPK



VVPL



WVPM



VVPN



WVPO



VVPP

PLEASE NOTE: GLASS IS NOT INCLUDED. ALL PANELS ARE BEADED, PLEASE SELECT EITHER FLUSH OR REBATED BEADING. Please contact your local merchant or glazier for glazing prices.

Hallmark Timber Veneer Doors

INTERIOR DOORS

NEW ZEALAND NATIVE DOORS

Hallmark's native veneer collection is made from New Zealand's finest timbers harvested only from managed forests. In the interests of sustainability, the Hallmark group is dedicated to the use of veneers from sustainably managed forests, to help preserve our timber resources and guarantee the renewal of that resource now and for the future.

Beneath the beautiful veneer finish, each door has a unique frame construction that provides a superior structural performance and minimises bowing problems to help keep your door functioning properly and looking superb.



NZ Heart Rimu



NZ Colour Rimu



NZ Economy Rimu

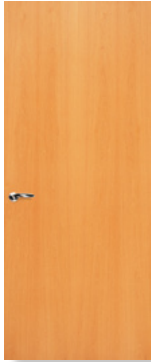

NZ Pale Rimu



NZ Tawa

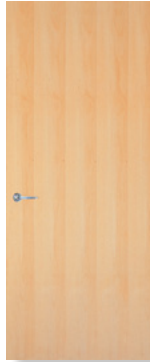

Southland Silver Beech



NZ Colour Beech

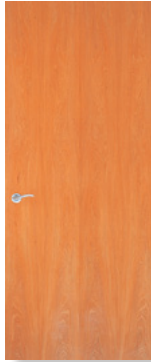

NZ Totara

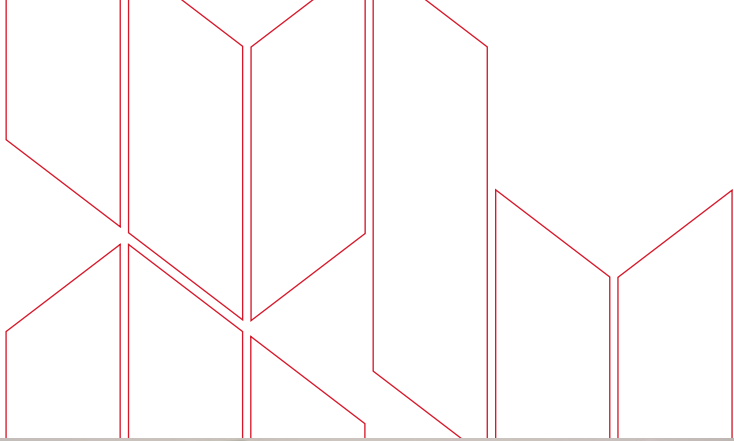

EXOTIC SPECIES DOORS



All Hallmark exotic veneers are imported directly from our suppliers around the world, and then carefully hand-selected when they arrive at our factory. This allows us to keep our quality level at its highest standard and control colour variations in the timber as much as possible. Please note that images are indicative only and veneers can differ from those shown here.

All doors are available in hollowcore, solidcore, polystyrene core. All doors are available up to 2700mm high. Other veneer options are available on request.

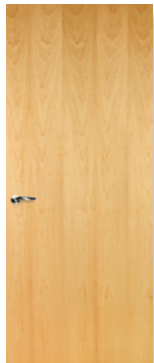

American Maple

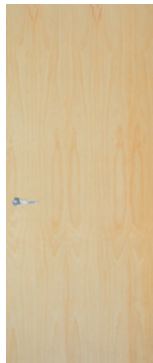

Radiata

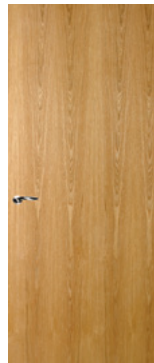

White Oak

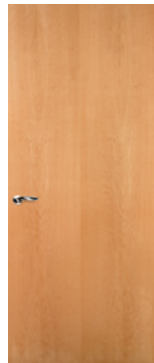

European Beech

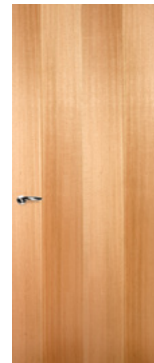

Tasmanian Oak

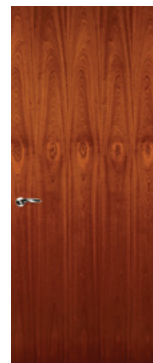

Sapelle Crown

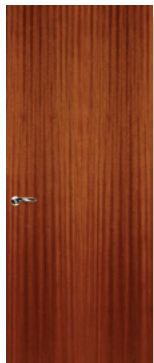

Sapelle Quarter



Jarrah



Anegre Quarter

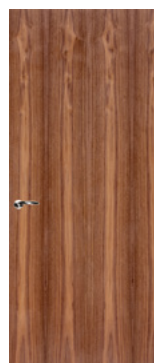

Walnut

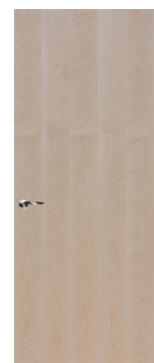

Euro Birch

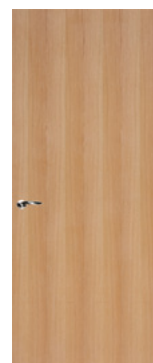

French Oak

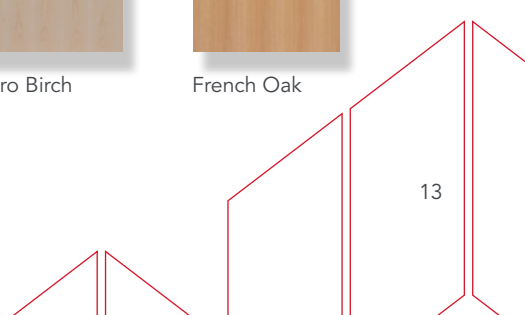

Hallmark Architectural Collection

INTERIOR DOORS

SPECIALTY VENEER DOORS

When it comes to designing and creating doors to meet the demanding specifications required by architects and interior designers, Hallmark is a market leader, with the expertise to create virtually any door to match any design concept. Whether the design is for a residential or commercial project, Hallmark can offer many eye-catching designs to meet and fully complement the designer's vision.

As many architectural specifications call for oversize doors, Hallmark has perfected the art of manufacturing these doors, using techniques to ensure maximum stability in use.



Heart Rimu / Oak
ARCH01

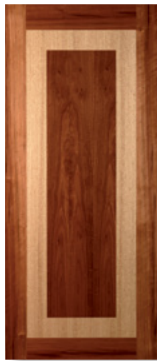

Jarrah / Tasmanian
Oak
ARCH02



Jarrah / Tasmanian
Oak
ARCH03

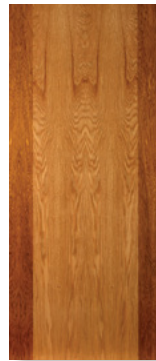

Rimu / American
White Oak
ARCH04



Tasmanian Oak /
Blackwood
ARCH05

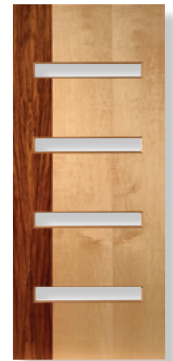

Yaka / Tawa
ARCH06



Tasmanian Oak /
Jarrah
ARCH07



Cherry / Maple
ARCH08



Tasmanian Oak /
Blackwood
ARCH09



Jarrah / Tasmanian
Oak
ARCH10

Steel inserts can be added to any size door upon request. All doors are available in hollowcore, solidcore, polystyrene core. All doors are available up to 2700mm high. Please note toning will vary from door to door. Other veneer options available on request. Sheltered exterior options available.

Hallmark Milano Collection

INTERIOR & SHELTERED EXTERIOR DOORS

SPECIALTY VENEER DOORS



For a total solid look door but with the stability benefits that an engineered design brings, look no further than the Hallmark Milano Collection. All designs have natural veneer faces bonded to exterior plywood. For grooved designs, solid matching timber inserts are utilised to ensure there is no visible plywood. Clashing strips are fully concealed on the door face.

All Milano Collection sheltered exterior doors must have a minimum 1200mm eaves cover. Steel inserts on two sides give the most stable sheltered exterior door available.

All designs available for interior applications.

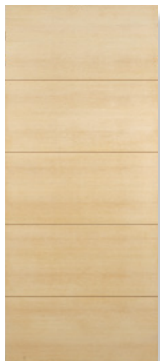

MLN1
TASI OAK



MLN2
NZ RIMU

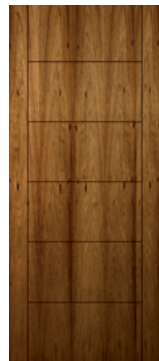

MLN3
BLACKWOOD



MLN4
AM. WHITE OAK



MLN5
JARRAH
(vertical grain flush panel)



MLN6
TASI OAK
(horizontal grain flush panel)

30 x 30mm STEEL INSERT DETAIL:

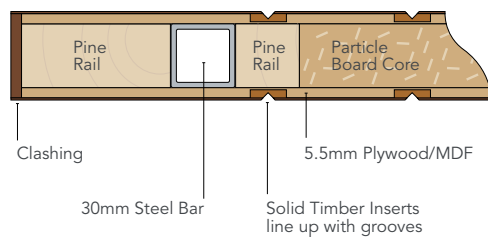

10 x 2mm ROUT DETAIL

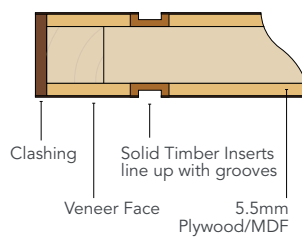

5 x 2.5mm V-GROOVE DETAIL

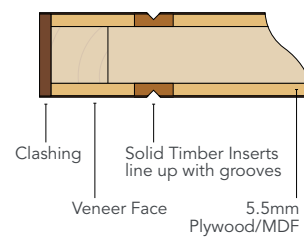

ALL DESIGNS AVAILABLE IN ANY OF THE FOLLOWING SPECIES:



Other species available on request.

Hallmark Cavity Sliders

INTERIOR DOORS

PREMIUM CAVITY SLIDERS



Hallmark Group had a goal to introduce a cavity slider into the market with four key factors in mind.

To be manufactured with the highest quality components, be easy to use and install, be uncomplicated and most of all, be affordable. We have achieved this with the latest addition to our range. Through years of experience, extensive research, development and testing, we introduce Hallmark premium cavity sliders.

Hallmark cavity sliders are all about creating more useable space. They are an excellent option where space is at a premium, and save almost 1m² of floor area needed for an average swinging door. Doors simply disappear inside the wall leaving floors and walls free, giving you more space for furniture, artwork, appliances and shelving.

Single cavity sliders are ideal for small space-constrained places, while larger double door units enable you to open up adjacent rooms and blend spaces together. Simply put, they're a great way of adding space to your home or office. Our products are manufactured to the highest standards and we are continually innovating with the latest technology to deliver the best solutions. Whether it be for the healthcare, education, accommodation, commercial or residential markets, Hallmark sets the benchmark in quality for New Zealand's door industry.



CAVZERO™

CAVZERO™
now available with all
Hallmark Cavity Sliders

STATE-OF-THE-ART HEAD TRACK

- › Guided track system. Doors perfectly centred every time – particularly critical for double doors.
- › Tapered design to prevent build-up of dust over time. This ensures your door will roll smoothly for years.
- › Especially designed for strength and longevity.

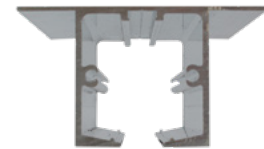

THE ULTIMATE IN RUNNING GEAR

- › Eight wheels per door! 2x4 wheel hangers per door spreads the load and makes your door easy to open and close.
- › 29mm diameter wheels. Your door will run smoothly and quietly.
- › 80kg and 120kg options available.



OUR QUICK RELEASE!

- › Simple but VERY effective. Easy to use, quick to install or remove door, and NOT OVER-ENGINEERED! You won't be paying for stuff you don't need.



EXTRA ADJUSTMENT

- › Things slightly out of square? Hallmarks patented floor guide system will help you out – you can adjust the guide left or right to suit.
- › Likewise, our brackets; when fixing these to the top of the door you've got adjustment forward, back and side to side. Handy if you get a door with a slight bow in it.
- › All units supplied with a spanner for adjustment.

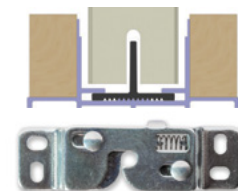

OUR SOFT CLOSE

- › Smooth, reliable, tested and proven. It's built to last and will protect your cavity slider and walls from unnecessary wear for years.



EVEN MORE BENEFITS

- › NZ Made and NZ owned
- › Standard sizes ex stock
- › Chunky aluminium extruded front stays prevent flex in opening jambs.
- › One stop shop – we'll supply your door and your cavity slider no problem. And whats more, our paint quality doors come with a moisture resistant UV coating on both faces.
- › For full warranty, refer to www.hallmarkgroup.co.nz
- › For full install instructions, refer to www.hallmarkgroup.co.nz

Hallmark Cavity Sliders

INTERIOR DOORS

PREMIUM CAVITY SLIDERS

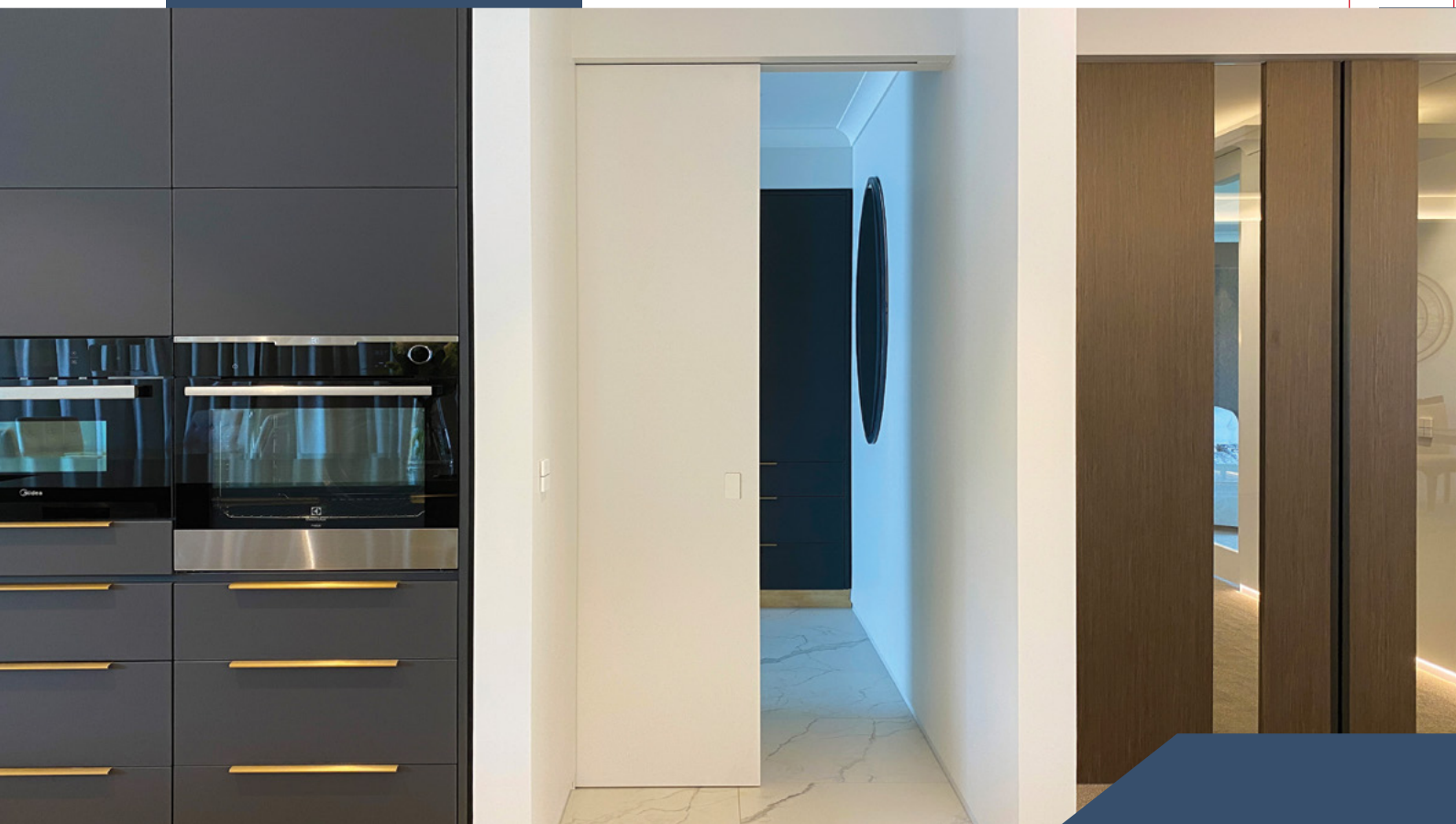

OUR PROMISE TO YOU

All Hallmark cavity sliders are produced from start to finish in a precision factory environment. Unlike other cavity slider manufacturers, we produce all our own timber components in our factory, giving us complete control and flexibility over the entire process. Our rollers, aluminium components and soft close system have been engineered to our specifications and have passed extensive cycle testing.

To maintain the Hallmark service and quality, we have a fully independent manufacturing facility set up for the production of cavity slider units. This allows the stocking of standard size units so we can ship to our customers on a daily basis.

At Hallmark we're all about the customer experience. We're focused on giving our customers a seamless and stress-free experience from the quoting stage right through to after-sales service. Should there ever be an issue, we don't stuff around pointing the finger, we just get in and make it right.



CAVZERO™
now available with all
Hallmark Cavity Sliders

CAVZERO™
system in full height door

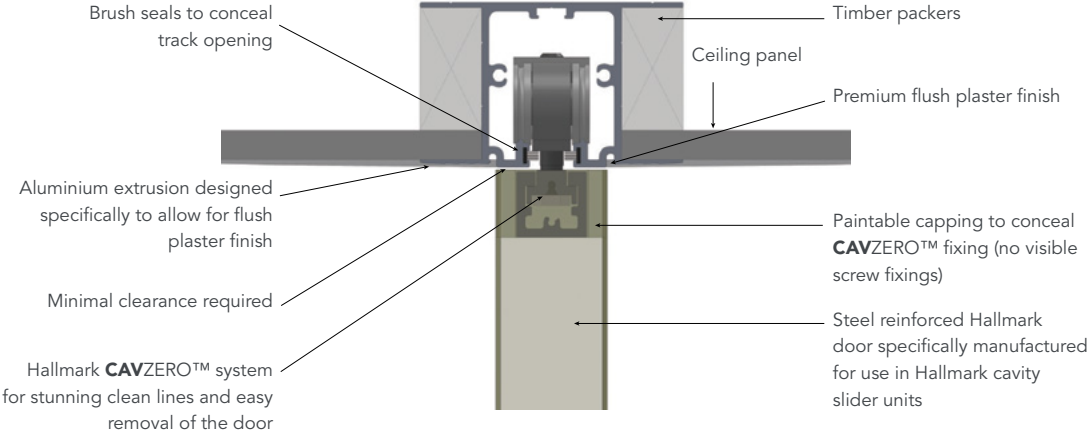

CAVZERO™
system in standard height door

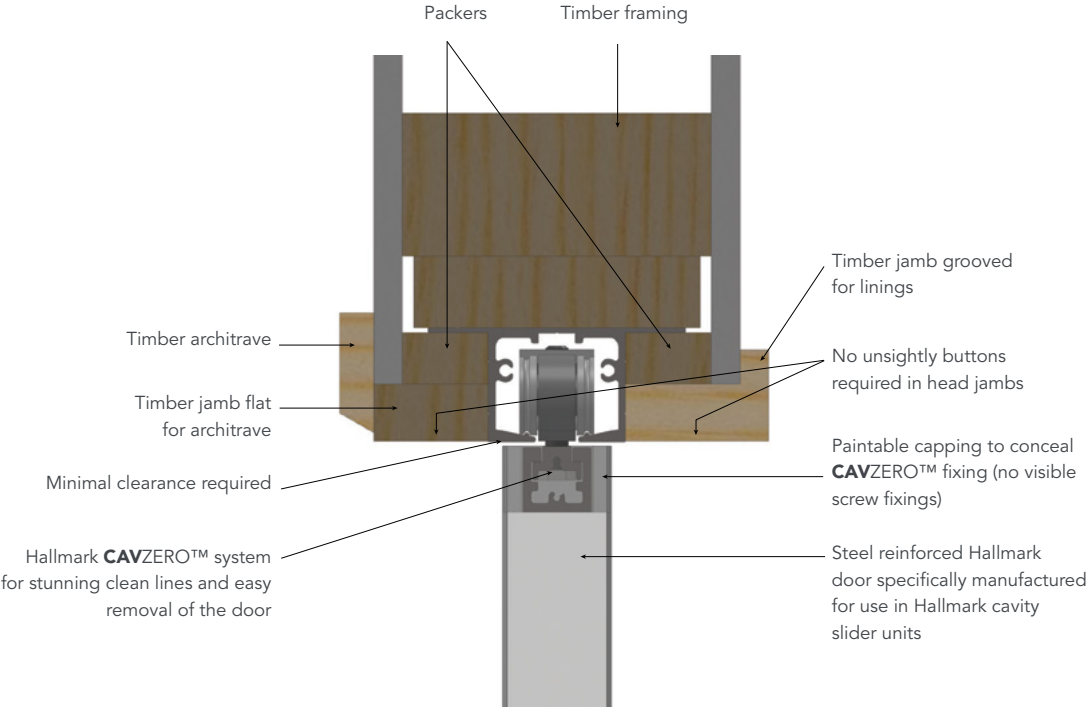

Hallmark Pre-Finished

INTERIOR DOORS

NO PAINTING/FINISHING REQUIRED

A market leading concept, Hallmark Group has now added a state-of-the-art range of pre-finished doors to our vast selection of options. An innovative new product, our pre-finished doors require no painting or finishing once installed and come in several stylish decors to suit any interior.

All doors are available up to 3000x1200x38 and with matching edging. Available in hollow core, polystyrene core or solid core. The PureMatte™ collection is available as flush panel only, vision panel options with aluminium beading available on request.

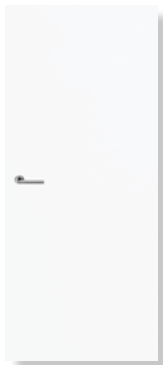

Dove

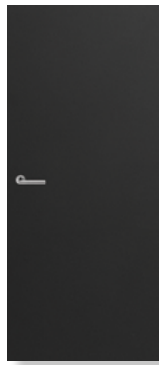

Raven



Mist

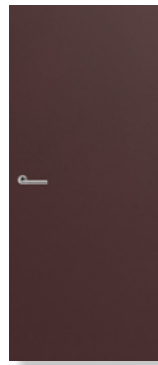

Syrah

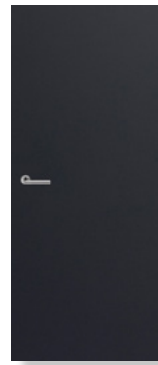

Atlantic



Riverstone

PureMatte™ Collection

When you select a door from the PureMatte™ collection, you are selecting the absolute latest in door surface technology. Featuring a high pressure laminate (HPL) with anti-fingerprint technology and a beautiful soft matte finish, PureMatte™ ensures function meets form. Easy to clean, resistant to scratching*, impact, heat, and staining, PureMatte™ is the next generation of high use surfaces. Should you want to match any cabinetry PureMatte™ can be pressed onto MDF or Plywood and used both vertically and horizontally.

Exclusive to Hallmark Group and available in 6 fashionable colours, PureMatte™ creates aesthetically pleasing interior surfaces that look and feel amazing. We strongly suggest you contact us to view samples so you can experience this technology, and feel the silky finish of the PureMatte™ collection for yourself.

Images are printed with the best print technology available. But no picture is as good as the real thing; please contact us to receive sampling before making your final decision.

*Specially hardened using electronic beam curing (EBC), PureMatte™ has level 2 scratch resistance in accordance to EN 438-3.

Hallmark Pre-Finished INTERIOR DOORS

NO PAINTING/FINISHING REQUIRED



Example of
PureMatte™ edge clashing

Pre-finished doors are a much-requested product from many professionals in the market, and after undertaking significant testing and development Hallmark Group has answered these requests with an exciting collection of doors to suit many different applications and budgets.

All doors are available up to 2400x1200x37 and with matching edging. Available in hollow core, polystyrene core or solid core. The DecoForme™ collection is available as flush panel only, vision panel options with aluminium beading available on request.

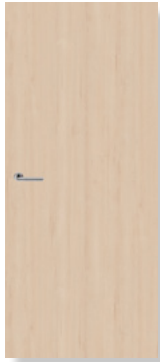

Tussock
Smooth Matt



Moss Grey
Smooth Matt

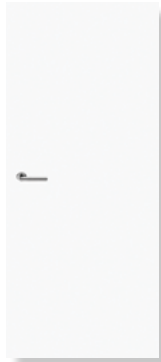

Polar White
Smooth Matt



Storm Smooth
Matt

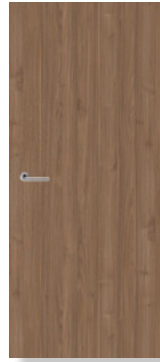

Woodland
Smooth Matt



Honey Oak
Texture Matt

DecoForme™ Collection

The DecoForme™ collection consists of both paint quality and veneer imitation low pressure laminate (LPL) designed for a wide range of applications such as office & shop fitout, hotels, accommodation and educational facilities. With the option of both woodgrain and paint decors available, the DecoForme™ collection provides a great option to any project where consistency of colour and toning is vital.

The specialised design of the DecoForme™ guarantees that you're selecting a product that is manufactured using modern production methods combined with the latest thinking in design and on-site efficiency. Upon receiving delivery of your doors, they simply get installed with no further painting or finishing required. We recommend installing after the walls are painted and the carpet is down.

Images are printed with the best print technology available. But no picture is as good as the real thing; please contact us to receive sampling before making your final decision.

Hallmark Urbinos

INTERIOR DOORS

ALUMINIUM JAMB SYSTEM



The two piece Urbinos aluminium jamb system is a must for any architect, builder or home owner looking for something that will set their project apart. With its crisp clean lines, option of prefinished surfaces, and efficient installation, Urbinos is the answer for every commercial and residential application. For detailed drawings please contact Hallmark Group on 0800 846 237.

35mm BACK SECTION

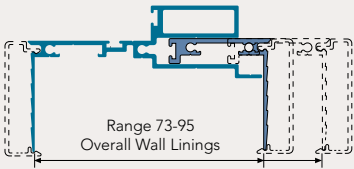

69mm BACK SECTION

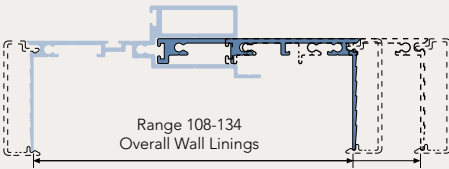

94mm BACK SECTION

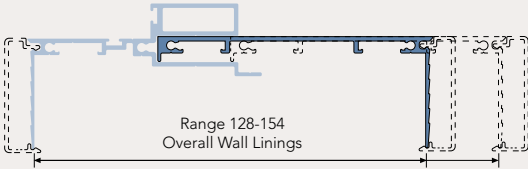

119mm BACK SECTION

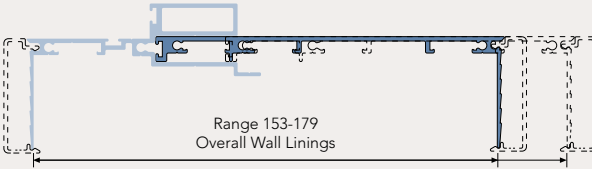

Available in mill, anodized or powdercoated (to any colour) finish, these door frames arrive on site fully assembled with the door already hung in the frame using high quality stainless steel hinges.

Easy to use, the streamline frames are a two piece system, consisting of a rebate section and one of four back sections depending on what your finished wall thickness is.

FLUSH FINISH DOOR FRAME

This system eliminates protruding interior trims and allows flush plastering to all corners and interior edges, allowing one space to seamlessly blend into another. The clean finish that conceals frames completely.

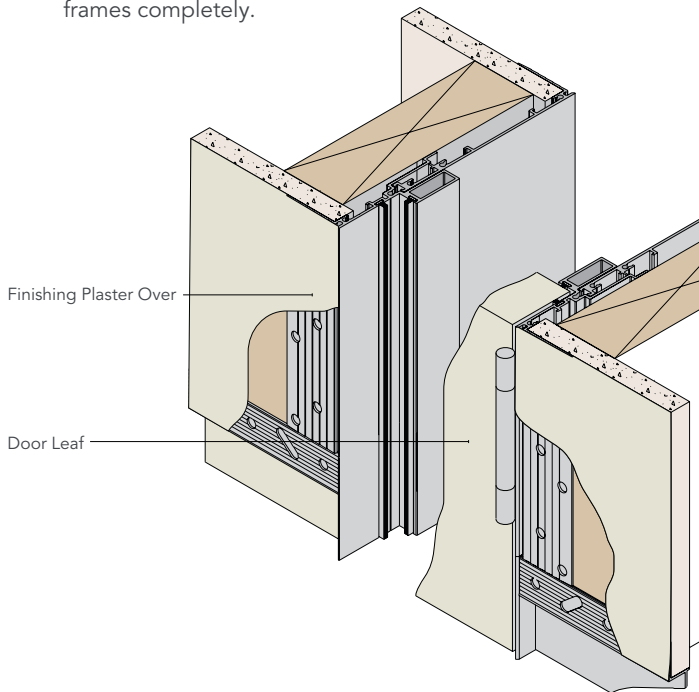

ARCHITRAVE FINISH

An aluminium prefinished system with clip on architraves. Very clean, tidy and very fast. Designed primarily for the health and commercial centre but fits equally well in those architectural homes of distinction.

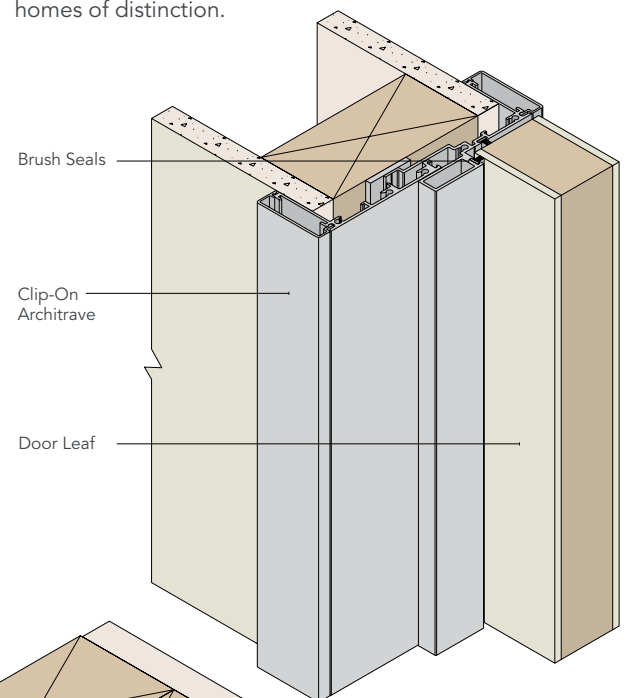

UNICO™ CONCEALED HINGE

For a completely concealed look, add the hallmark Unico hinges to your flush finish door frame. No visible hinges, just nice, clean modern lines.

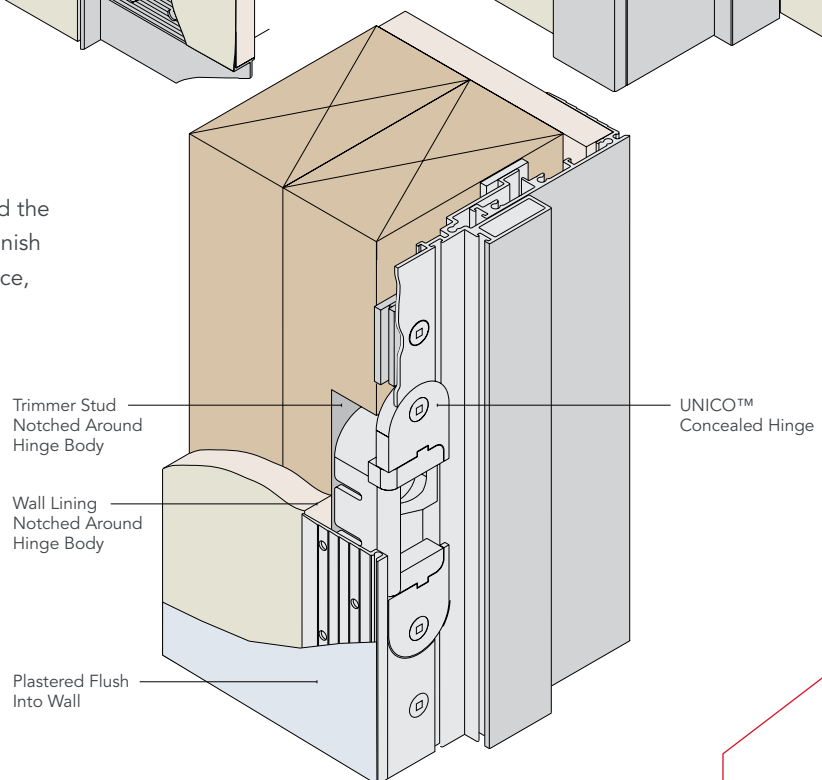
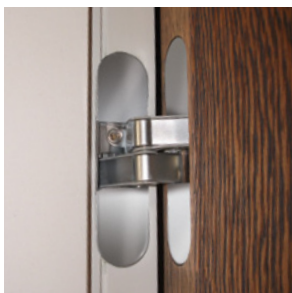

Hallmark Fire Doors

SMOKE & FIRE RATED DOOR SETS

HOTEL / COMMERCIAL / EDUCATION / HOSPITAL & REST HOME



Hallmark manufactures an extensive range of smoke and fire rated door sets. With over 500 approvals to strict Australian and New Zealand standards, Hallmark rated performance door sets are fast becoming the preferred choice.

From applications requiring 30 minute doors (HFD30), through to 240 minute doors (HFD240), Hallmark fire doors with their highly specialised non-combustible core, give you assurance and peace of mind.

Hallmark fire doors can be supplied in a huge range of approved options, including: door types, vision panels, glazing, facings, kick plates and hardware. The list is endless. Call our engineers to get it right first time.

Hallmark also manufactures other speciality doors for specific applications such as doors to meet special sound (STC) ratings, sliding doors, X-Ray room doors, and speciality doors for hygienic applications. All performance doors are supplied prehung as a door set comprising the frame, hinges, seals and vision panels all factory fitted. Regardless of your application, Hallmark can supply approved rated doors to rigid specifications and quality standards.

Door Options (Ratings):



Door Closers

Fire doors require an approved self closing device i.e. a door closer. Door closers must be subject to a fire test and approved.



Vision Panel Options

- › Timber or aluminium beads
- › Georgian wire glass up to 650 x 600mm
- › Robax glass up to 650 x 600mm
- › Pyrobel 16mm up to 800 x 500mm (fully insulated to 30mins)



Acoustic Rated Door Sets

Hallmark offer a range of acoustic door sets ranging from STC 30 up to STC 48 for interconnecting hotel doors. Ratings are subject to the type of wall and accuracy of installation. For fire acoustic doors, the fire approval limitations on design and hardware apply.

Frame Options

- › PQ FJ pine timber frame 30mm thick (up to FRR - / 30 / 30)
- › PQ hardwood timber frame 30mm thick (up to FRR - / 60 / 30)
- › Steel frame 38mm thick - (up to FRR - / 240 / 30)
- › All timber frames available as architrave or grooved for gib
- › Steel frames available as one or two part, powder coated, or stainless finish



Mortise Locks

Mortise locks are the most common door lock fitted to fire doors. Hallmark has all of the approved major brands and types available. In limited applications cylindrical locks can also be fitted. If in doubt or you need assistance to select the right hardware, contact our engineers.



Furniture & Accessories

A wide range of furniture and speciality hardware is available – electronic locks, electric strikes, panic exit devices, eye viewer's, double action pivots, smoke seals, drop seals etc.



Hallmark Door Warranty

All Hallmark doors are covered by the Hallmark Doors Warranty. Hallmark doors are manufactured to strict quality standards and hopefully you never need to make a warranty claim. However all doors are made from timber products and thus are subject to movement. Our warranty covers door movement beyond specified limits.



Hallmark Interior Doors

Warranty

Hallmark doors are manufactured with the highest craftsmanship and carry a five-year warranty provided all storage, handling, finishing and hanging instructions are followed.

Hallmark doors are warranted against defects in workmanship and materials, specifically delamination of veneer, or clashings, separation of the skin from the core, veneer splits and excessive distorting from tolerance. The manufacturer will not be held responsible for additional charges of hanging, painting or other charges arising from the replacement of doors.

Storage and Handling

Inspect all doors upon arrival for freight damage and visible defects. The manufacturer must be notified within four days if damage has occurred. Any claims outside of this time frame cannot be recognised.

- › Show through of any components on a 3mm skin door is not considered a defect.
- › Warp exceeding 5mm shall be considered a defect on doors up to 2400x910mm. This excludes cavity slider doors, see points below.
- › Doors exceeding this size carry no guarantee against warp. The manufacturer will accept no responsibility for defective doors when the moisture content of the timber exceeds 18%.
- › All doors for cavity slider units must have steel inserts to maintain stability. Door leaves up to

1980x810mm require steel inserts on 1 edge, preferably both edges. Door leaves that exceed either 1980mm high or 810mm wide require steel inserts on both edges. Door leaves with steel 2 sides are covered under warranty up to a size of 2700x1210mm. Door leaves exceeding this size are not covered under warranty. Please note that warping less than 5mm is not considered a defect and is not covered under warranty.

- › Doors must be stored flat in a clean, dry area away from direct sunlight. A flat MDF cover sheet must be placed on the top door at all times should it be exposed.
- › Variations in colour are not considered a defect.

Finishing

When finishing, ensure the door is dry and free from dust and grime. The two faces and all four edges of the door must be sealed and coated (including lock holes and check outs) within four days of arriving on site. Linseed oil or Linseed oil based products are not to be used on any of Hallmark's interior doors. Staining is at your own risk. Hallmark Doors do not accept any liability for the finished quality of a stained door. Coating 'slump' on the veneer joins is normal and will not be considered a defect. The manufacturer is not liable for the paint finish. Any fibre raise should be sanded flat before coats are applied. Fibre raise is a natural reaction and is not considered a defect.



Interior doors must not be painted in dark colours as these colours tend to absorb more heat and may cause the door to distort. A light colour has a Light Reflectance Value (LVR) greater than 40 (white is 100, black is zero). Refer to your paint manufacturer for further advice. Note: dark colours on any interior door will void the warranty.

Installation

- › All interior doors must be installed in dry buildings only. Doors installed in situations with excessive air movement (i.e. buildings not at 'lock up' stage) void the warranty.
- › Interior doors must not be installed within the direct air movement of an air temperature controller.
- › All doors must have at least three hinges. Doors over 2200mm high must have four hinges.

Care and Maintenance

Hallmark interior doors are designed for interior use only and should never be used in a situation subject to exterior conditions, high moisture or high temperature fluctuations such as spa or sauna rooms.

Doors installed in bathrooms or laundries that become scratched or damaged are to have the coating repaired immediately. Any repair work must be carried out under the instructions of the coating manufacturer.

Technical Information

Tolerances:

- +/- 2.0 mm for width, height and thickness
- +/- 3.0 mm for squareness across the diagonal of the door
- +/- 5.0 mm for twisting or bowing

Conditions & Limitations

The warranty does not apply if:

- › Damage is caused by normal wear and tear or by circumstances outside of Hallmark Doors' control.
- › Installation, storage, handling, maintenance, uses or repairs are not carried out under the manufacturer's instructions.
- › Extra facings such as mirrors, MDF, veneer



panelling or similar products are affixed to any face of the door, post manufacture. Other laminate products such as HPL and vinyl will require prior approval from Hallmark.

Note

- › Information and specifications may change without notice.
- › Timber colours and grain patterns may vary from those illustrated in our brochure.

Hallmark Exterior Doors

Warranty

To be read in conjunction with Hallmark interior doors warranty. Hallmark exterior doors carry a five year warranty against defects in workmanship, materials and excessive distortion from tolerance. All technical information, storage and handling specifications are as per the Hallmark interior doors warranty. Exterior doors installed in a situation with high temperature fluctuations such as spa or sauna rooms carry no warranty against warp.

Uses

- › Sheltered exterior with adequate eaves covering. (minimum 1200mm).
- › General interior

Limitations

- › Unprotected exterior use
- › Saunas, steam rooms, smoke houses etc.
- › Fire doors

Finishing

Exterior finishes must be used on all exterior doors. All doors must be fully painted with a full coating system prior to site installation. Exterior doors must not be painted in dark colours as these colours tend to absorb more heat and may cause the door to distort. A light colour has a Light Reflectance Value (LVR) greater than 40 (white is 100, black is zero). Refer to your paint manufacturer for further advice.

Note: dark colours on any exterior door will void the warranty.



Contact us:

P: +64 3 313 4754

0800 TIMBER (NZ only)

F: +64 3 310 7160

E: sales@hallmarkgroup.co.nz

W: www.hallmarkgroup.co.nz

355 Flaxton Rd, PO Box 413
Rangiora 7440, New Zealand